



# Waste generation, wealth and GHG emissions from the waste sector: Is Denmark on the path towards circular economy?



Cosimo Magazzino<sup>a</sup>, Marco Mele<sup>b</sup>, Nicolas Schneider<sup>c</sup>, Samuel Asumadu Sarkodie<sup>d,\*</sup>

<sup>a</sup> Roma Tre University, Italy

<sup>b</sup> University of Teramo, Italy

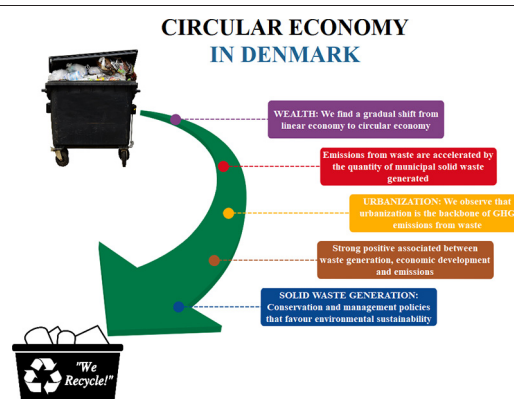
<sup>c</sup> Paris 1 Panthéon-Sorbonne University, France

<sup>d</sup> Nord University Business School (HHN), Post Box 1490, 8049 Bodø, Norway

## HIGHLIGHTS

- In-depth assessment of Municipal Solid Waste Sustainability is presented.
- We assess the effect of wealth and urban sprawl on sustainable waste management.
- We observe that urbanization is the backbone of GHG emissions from waste.
- We find a gradual shift from linear economy to circular economy.
- Other countries can learn from Denmark's path towards sustainable waste management.

## GRAPHICAL ABSTRACT



## ARTICLE INFO

### Article history:

Received 11 July 2020

Received in revised form 24 August 2020

Accepted 17 September 2020

Available online 25 September 2020

Editor: Daniel CW Tsang

### Keywords:

Municipal solid waste

Breitung-Candelon spectral Granger-causality

Waste sector

Recycling

Environmental sustainability

Machine learning

## ABSTRACT

Municipal solid waste (MSW) is one of the most urgent issues associated with economic growth and urban population. When untreated, it generates harmful and toxic substances spreading out into the soils. When treated, they produce an important amount of Greenhouse Gas (GHG) emissions directly contributing to global warming. With its promising path to sustainability, the Danish case is of high interest since estimated results are thought to bring useful information for policy purposes. Here, we exploit the most recent and available data period (1994–2017) and investigate the causal relationship between MSW generation per capita, income level, urbanization, and GHG emissions from the waste sector in Denmark. We use an experiment based on Artificial Neural Networks and the Breitung-Candelon Spectral Granger-causality test to understand how the variables, object of the study, manage to interact within a complex ecosystem such as the environment and waste. Through numerous tests in Machine Learning, we arrive at results that imply how economic growth, identifiable by changes in per capita GDP, affects the acceleration and the velocity of the neural signal with waste emissions. We observe a periodical shift from the traditional linear economy to a circular economy that has important policy implications.

© 2020 The Author(s). Published by Elsevier B.V. This is an open access article under the CC BY-NC-ND license (<http://creativecommons.org/licenses/by-nc-nd/4.0/>).

## 1. Introduction

The impact of COVID-19 pandemic on municipal waste accentuates the importance of sustainable waste management (Sarkodie and Owusu, 2020). The UN Conference of Sustainable Development

\* Corresponding author.

E-mail addresses: [cosimo.magazzino@uniroma3.it](mailto:cosimo.magazzino@uniroma3.it) (C. Magazzino), [mmele@unite.it](mailto:mmele@unite.it) (M. Mele), [Nicolas.Schneider@etu.univ-paris1.fr](mailto:Nicolas.Schneider@etu.univ-paris1.fr) (N. Schneider), [asumadusarkodiesamuel@yahoo.com](mailto:asumadusarkodiesamuel@yahoo.com) (S.A. Sarkodie).

(UNCSO) parties clarified the definition of Sustainable Development (SD) (Barbier, 2011; Wanner, 2015). It is defined as one that meets our present needs while allowing future generations to address their own. Meanwhile, the concept of Green Growth (GG) has emerged as a low-carbon and climate compatible development pattern. Challenges with Municipal Waste (MW) stands at the core of these comprehensive reforms since the effectiveness of the waste management sharply influences environmental quality. One reason is that global material use is expected to double by 2060, with obvious dramatic consequences on human health and the environment (OECD, 2019b). When treated (i.e., abandoned or deposited in open dumps), Municipal Solid Waste (MSW) generates harmful and toxic substances through its direct release into soils<sup>1</sup> (Ludwig et al., 2003; Ali et al., 2014). When treated (i.e., collected and deposited in waste treatment facilities), it produces an important amount of polluting emissions (notably methane gas)<sup>2</sup> responsible for global warming (IPCC, 2007; Bogner et al., 2008; Clarke et al., 2019). Accordingly, it has been underlined that MSW must be the subject of important *ex-post* management, but also important *ex-ante* regulations (Ayalon et al., 2001). In line with a sustainable path, minimising waste through recovery or turning waste into energy are key areas in which circular business models<sup>3</sup> can operate (Malinauskaite et al., 2017; D'Adamo et al., 2019; OECD, 2020).

Facing this challenge, the European Union (EU) Sixth Environment Action Programme (2002–2012) listed waste reduction as one of its most urgent priorities (Sjöström and Östblom, 2010). Thus, EU policies have been promoting sanitary landfill and waste recovery for a decade (Sokka et al., 2007; Das et al., 2019). These global measures find their origin in a current concern: the total quantity of MSW per capita increased by 54% in the EU15 over the 1980–2005 period (Sjöström and Östblom, 2010). And this trend holds also for Denmark, where the per capita MSW increased by 43.4%<sup>4</sup> between 1994 and 2018 (OECD, 2019a). Looking at the per capita income, this indicator recorded a 33% growth over the same period (WDI, 2019). However, the environmental costs related to MSW might still have decreased due to national waste management policies. Indeed, the Danish government has adopted several policy measures in parallel to the EU's effort: reducing landfilling, increasing processing for recycling, and improving composting<sup>5</sup> (Andersen and Larsen, 2012). As a result, over the period 1993–2018, municipal waste recovery increased from 80% to 99%; composting increased from 9% to 17% and landfilling<sup>6</sup> decreased from 20% to 1% (OECD, 2019a). Danish households are also large food waste producers in Europe, totalling 237,000 t annually (Kjær and Werge, 2010). Hence, in 2011, the Danish Ministry of the Environment established an "Initiative Group Against Food Waste" composed of stakeholders from public and private sectors and aiming at achieving food waste reduction (Halloran et al., 2014). Finally, waste-to-energy (WTE) processes have been strongly promoted across the territory through non-profits WTE plants owned by municipalities (Tomić et al., 2017). The effective impact of these policies appears fruitful: GHG emissions from the waste

sector recorded a 32%<sup>7</sup> decrease over the period 1994–2017. Denmark (which has greatly exceeded the EU goals) is even considered as one of the most advanced waste management systems, making even extra income from the import and disposal of waste from neighbouring countries (Tomić et al., 2017). On the other hand, the last OECD report on the environment ranked Denmark as the second largest MSW producer per capita among OECD countries (after New-Zealand). With 771 kg per capita, this economy is well above the OECD average estimated at 524 kg per capita. As in most economies, MSW generation continues to increase in Denmark (it was stated at 751 kg per capita in 2013), indicating that this country has not yet managed to decouple waste generation from socio-economic developments. Facing such a burning environmental paradox, the case of Denmark is of high interest.

Before designing any recommendations, understanding the nature of the growth-environmental degradation relationship is mandatory. A first strand of the literature examined the determinants of MSW generation at various levels (Johnstone and Labonne, 2004; Karousakis, 2007; Chalakov et al., 2016). Upon the identified key drivers, the role of income turned out to be considerable but sensitive to the country's stage of development (Liu and Wu, 2011). Evidence of a progressive de-linking process in advanced economies has been early noted by the OECD. In theory, such decoupling phenomenon may occur when the elasticity of the MSW generation indicator in relation to per capita income is positive (but less than unity; relative de-linking), before becoming negative (absolute de-linking) (Mazzanti, 2008). Only in that case does income cease to be a robust driver to environmental degradation. In practice, its empirical assessment has been made using the well-known Environmental Kuznets Curve (EKC) approach (Kuznets, 1955; Grossman and Krueger, 1991). While many times documented in the literature, generalizing the inverted U-shaped curve for high-income countries is still conflicting.<sup>8</sup> This is notably due to the variety of methodologies employed and sample selected, calling for further inquiry into the waste-income nexus using a more consistent empirical strategy.

A second branch of the literature is constituted of studies relying on the EKC framework to investigate the link between economic growth and environmental pollution (Grossman and Krueger, 1991; Sarkodie and Strezov, 2019; Stern and Common, 2001; Bilgili et al., 2016). Since sectoral analyses have taken a growing place in this research field, a few published works explored the determinants of GHG emissions from the waste sector, inducing worthwhile policy implications (Lee et al., 2016; Dong et al., 2017). In practice, the waste sector is said to have high potential in curbing environmental pollution despite an important carbon footprint (Yi et al., 2014). Hence, numerous strategies for GHG abatement in the waste sector have been proposed at different locations: landfill extension and energy recovery system for waste disposal (Woon and Lo, 2013 - Hong Kong, China); higher energy recovery (notably landfill gas) efficiency from waste incineration for combined heat and power generation (Yang et al., 2012 for China; Yi et al., 2014 for Daejeon, Korea); Food waste treatment including thermal treatment, compost and anaerobic digestion (Bernstad and Jansen, 2012 for Sweden).

Nonetheless, an in-depth review of the literature highlights that none of these studies examined the relationship among MSW generation, income and GHG emissions within a single framework.<sup>9</sup> Yet, it is known that a neighbouring assessment on the interrelationships

<sup>1</sup> Mainly chlorinated solvents, heavy metals, polycyclic aromatic and aromatic hydrocarbons, and vinyl chlorides.

<sup>2</sup> According to the World Resource Institute (WRI, 2013), methane gas represents 15% of the total GHG emissions and is also the main contributor to GHG emissions in the waste sector.

<sup>3</sup> The OECD (2020) defines a circular economy as a system which maximises the value of the materials and products that circulate within the economy. Allowing for sharp resources preservation and environmental footprint reduction, circular business models are attracting a growing attention from researchers, governments, and industries. For an in-depth assessment on the potential of waste recovery and waste-to-energy under a circular economy environment in Europe, see Malinauskaite et al. (2017).

<sup>4</sup> MSW generation per capita increased from 537.7 kg per capita to 771.1 kg per capita over the 1994–2018 period (OECD, 2019a).

<sup>5</sup> In fact, waste is taxed in Denmark to promote recycling over the waste incineration and landfilling (Tomić et al., 2017).

<sup>6</sup> By contrast, landfilling remains the main waste disposal method in OECD countries, indicating a considerable step in the sustainable direction for Denmark (OECD, 2019c).

<sup>7</sup> GHG emissions from the waste sector recorded a decrease from 1699.9 to 1145.9 thousand tonnes of CO<sub>2</sub> equivalent over the 1994–2017 period (OECD, 2019b).

<sup>8</sup> For instance, Mazzanti and Zoboli (2005) and Mazzanti (2008) carried an empirical analysis on EU countries and concluded that estimated waste elasticities were far from confirming the EKC hypothesis. Similarly, Cole et al. (1997) found no turning point for 13 OECD countries.

<sup>9</sup> In fact, Lee et al. (2016) and Magazzino et al. (2020a) estimated two distinct models (for the US and Switzerland, respectively). In the first model, they assessed the link among per capita GDP and MSW generation; and in the second model, they explored the relationship between total MSW, recovery waste generation, and GHG emissions from the waste sector.

among energy consumption, Gross Domestic Product (GDP), and CO<sub>2</sub> emissions has been extensively performed<sup>10</sup> (Lozano and Gutierrez, 2008; Magazzino, 2016; Magazzino and Cerulli, 2019; Sarkodie, 2021). Being of central importance in growth theory and providing far-reaching policy implications, linking waste-GDP and GDP-environmental pollution data in a unique estimation model can represent a fruitful research direction. If it is confirmed that GHG emissions from the waste sector are both driven by per capita MSW and income, then focusing on these key factors would help policymakers mitigating global warming. Reciprocally, if income is identified as the main determinant of waste generation, then adequate measures can be implemented. Accordingly, this is where our paper finds the first of its five contributions.

Looking with closer scrutiny, most published works have focused on large groups of advanced economies (EU, OECD) including often heterogeneous panel members in a single estimation. Due to the well-known waste data constraint,<sup>11</sup> it is not clear that the results obtained based on wide income groups can be generalized for each member. Besides, OECD and EU datasets may differ depending on the national waste classifications (Johnstone and Labonne, 2004). Yet, the knowledge on MSW with readily available waste statistics allow for single-country analysis.<sup>12</sup> While never studied in previous research, analysing the waste sector in Denmark stands as the second contribution of the present work.

Third, studies on the waste sector remain sporadic and limited despite its significant global warming contributor. The Sustainable development goal 12 accentuates the importance of sustainable production and consumption (United Nations, 2015), hence, a part of the debate on Sustainable Development (SD) should focus on waste management. Accordingly, this paper follows Domingos et al. (2017) and contributes to the literature in analysing the waste sector.

A fourth novelty aspect is methodological. This research relies on a Machine Learning (ML) methodology through the Artificial Neural Networks (ANNs). Our empirical approach differs from the great majority of existing analyses on this topic. Nonetheless, the few studies that used ML models on waste data failed to include additional variables within a multivariate predictive causality framework (Kannangara et al., 2018; Meza et al., 2019; Pan et al., 2019). Beyond a simple forecasting purpose, the present study relies on an innovative algorithm to perform a strong causal analysis among multiple variables.

Finally, urbanization is included as an additional explanatory factor to land and air degradation. This last original aspect is based on the household utility maximization proposed by Kinnaman and Fullerton (1997). The authors identified a vector of demographic characteristics towards which the use of household MSW is dependent, and notably the fact to live in urban areas or not. Then, Johnstone and Labonne (2004) adapted this model with macroeconomic data to assess the determinants of MSW generation for 30 OECD countries. To do so, they rely on the proportion of the urban population. A more urbanized population is said to exert growing pressure on urban resources and environment (Kasman and Duman, 2015; Magazzino and Cerulli, 2019). Undoubtedly, this factor is thought to be a non-negligible driver of MSW generation and GHG emissions. Hence, there is a point in incorporating it within our framework.

<sup>10</sup> Outside the waste framework, the empirical relationship between GDP, CO<sub>2</sub> emissions and various sources of energy has been extensively tested. See Pao and Tsai (2011); Tiwari (2011); Farhani and Ben Rejeb (2012); Magazzino (2014); Kasman and Duman (2015); Munir et al. (2020) for the relevant literature on this topic, which is not the explicit aim of this paper.

<sup>11</sup> The literature lacks single-country case studies mainly because of the data constraint. Waste classifications may vary across countries and care must be taken when working with data reported before the 1990s. For an interesting discussion on the data quality issue related to the waste sector, see Mazzanti et al. (2006).

<sup>12</sup> Beforehand, Mazzanti (2008) used the information available at that time and investigated the waste-GDP nexus for 15 EU countries. Due to a time-limited dataset (1997–2001), the authors stated that his research would only provide “preliminary evidence”. Hence, the current available statistics allow us to make a step forward here.

Overall, this paper aims at performing an in-depth assessment on Denmark: a case study characterized by a promising (but fragile) path to MSW sustainability. With five distinct novelty aspects, this research seeks to contribute to the literature. We exploit the most recent and available data period (1994–2018) and investigate the causal relationship between per capita GDP, urbanization, MSW generation per capita, and GHG emissions from the waste sector in Denmark. Following Magazzino et al. (2020a), this study applies two independent empirical strategies: a time-series analysis (the Breitung-Candelon Spectral Granger-causality test) and a Machine Learning approach (Artificial Neural Networks experiments), useful for policy formulation.

Besides this introduction, the remainder of the paper is organized as follows. Section 2 presents the literature. Section 3 introduces and describes the data and methodology employed. Section 4 shows the empirical results and discussion of the results. Finally, Section 5 provides concluding remarks and careful policy recommendations.

## 2. Literature review

The literature on the relationship between economic activity and environmental degradation can be divided into two main components. The first focuses on the economic growth-environmental pollution nexus (mainly carbon dioxide (CO<sub>2</sub>) emissions). The second concentrates on the link between economic growth and land degradation (i.e., waste generation). In the third part, this review highlights studies on green supply processes and a specific focus is made on waste treatment within circular models. Being nonetheless exhaustive, this survey emphasizes the suitability of assessing the Danish case and shed light on the key gaps in the literature.

### 2.1. Economic growth-environmental pollution nexus

As mentioned previously, the relationship between economic activity and environmental pollution has been abundantly studied using the EKC framework. The origins of this assessment can be traced back to the seminal study from Grossman and Krueger (1991). When confirmed, this hypothesis claims that environmental pollution would first increase with income, and then decreases as GDP grows and technological progress emerges (Rothman and De Bruyn, 1998; Lee et al., 2016). From a policy standpoint, it is of high interest to know what relation characterizes the GDP-CO<sub>2</sub> emissions nexus for a country (Magazzino and Cerulli, 2019). Despite abundant empirical examinations, studies differ from each other in terms of methodologies, time periods, and samples (Acaravci and Ozturk, 2010; Bowden and Payne, 2009; Bilgili et al., 2016). This review focuses on our country of interest: Denmark. Since the economic growth-waste generation nexus is the explicit aim of this paper, we select the only relevant information related to previous GDP-environmental pollution investigations. Nonetheless, an extensive overview can be found in Bilgili et al. (2016).<sup>13</sup>

The EKC is validated in Acaravci and Ozturk (2010) for 19 European (EU) countries (including Denmark), and using Autoregressive Distributed Lag (ARDL) bounds cointegration analysis (Pesaran and Shin, 1998; Pesaran et al., 2001) and Error Correction Model (ECM). Subsequently, the EKC is supported in Ben Jebli et al. (2013) for 25 OECD (Organization for Economic Cooperation and Development) countries (including Denmark). While results provided little evidence supporting the existence of the EKC hypothesis for Arctic countries (Baek, 2015), Bilgili et al. (2016) confirmed the EKC hypothesis for 17 OECD countries (including Denmark), through Fully Modified Ordinary Least Squares (FMOLS) and Dynamic Ordinary Least Squares (DOLS) estimations. Overall, despite not explicitly providing support for the EKC hypothesis, Saidi and Hammami (2015) showed that CO<sub>2</sub> emissions have a strong

<sup>13</sup> Broad critical surveys are also presented in Dasgupta et al. (2002), Dinda (2004), and Stern (2004).

**Table 1**  
Summary of previous studies on the relationship between GDP and CO<sub>2</sub> emissions including Denmark.  
Source: our elaborations.

Author(s)	Countries	Sample period	Methodology	Pollution/GDP data	EKC for Denmark
Acaravci and Ozturk (2010)	19 EU countries	1960–2005	ARDL, ECM	CO <sub>2</sub> emissions/GDP per capita	Yes
Ben Jebli et al. (2013)	25 OECD countries	1980–2009	FMOLS, DOLS	CO <sub>2</sub> emissions/GDP	Yes
Shafiei and Salim (2014)	29 OECD countries	1980–2011	STIRPAT model, GC	CO <sub>2</sub> emissions/GDP per capita	No
Baek (2015)	Arctic countries	1960–2010	ARDL	CO <sub>2</sub> emissions/GDP per capita	Yes
Bilgili et al. (2016)	17 OECD countries	1977–2010	FMOLS, DOLS	CO <sub>2</sub> emissions/GDP per capita	Yes
Domingo et al. (2017)	EU countries	1995–2012	ARDL	GHG emissions from the waste sector/GDP	No
Beşe and Kalayci (2019)	Denmark, Spain, and the UK	1960–2014	ARDL, GC, TY	CO <sub>2</sub> emissions/GDP	No

Notes: EU: European Union. OECD: Organization for Economic Cooperation and Development. ARDL: Autoregressive Distributed Lag bounds; ECM: Error Correction Model; FMOLS: Fully Modified Ordinary Least Square estimation; DOLS: Dynamic Ordinary Least Square estimation; STIRPAT model: Stochastic Impacts by Regression on Population, Affluence, and Technology model; GC: Granger Causality test; GMM: Generalized Method of Moments; TY: Toda and Yamamoto causality test.

negative impact on per capita GDP for 58 countries (including Denmark).

Inversely, the EKC hypothesis is rejected in Shafiei and Salim (2014) for 29 OECD countries (including Denmark) while using the Stochastic Impacts by Regression on Population, Affluence, and Technology (STIRPAT) model. As in Beşe and Kalayci (2019) who applied ARDL, GC and Toda-Yamamoto (TY, Toda and Yamamoto, 1995) causality tests, the EKC is rejected for Denmark, Spain, and the United Kingdom.

Focusing on a neighbouring research issue, Silva et al. (2012) applied Impulse Response Function (IRF) models and showed that income and CO<sub>2</sub> emissions variables are overly sensitive to changes in the share of renewable energy sources in the energy mix for Denmark. Despite not confirming the EKC hypothesis, such results underline the persisting linkages among energy, income, and pollution. Overall, previous research demonstrated that extracting renewable fuel from MSW helps to reduce GHG emissions from the waste sector in the EU (Domingos et al., 2017). Table 1 summarizes the main information of the empirical EKC literature.

## 2.2. Municipal solid waste-income nexus

MSW is a major component of total waste generation and is obviously linked to land degradation. Hence, the EKC framework has been extensively employed to inspect per capita MSW-GDP relationship. Nevertheless, income-land degradation nexus remains under-investigated. As for GDP-CO<sub>2</sub> studies, the Danish case appears only considered through multi-country examinations so far.<sup>14</sup>

The first strand of studies explored the determinants of MSW generation, underlining the key role played by income in MSW generation. The seminal contribution from Johnstone and Labonne (2004) focused on 30 OECD countries (including Denmark) and investigated the macro-economic determinants of household solid waste generation. Applying panel estimation over the period 1980–2000, the results clearly showed that economic activity and population density are two robust drivers of solid waste. This finding is in line with Karousakis (2006) who performed a neighbouring examination including a waste legislation index on the same sample. Empirical results showed that MSW increases linearly with income. While the time-invariant policy index is not significant, urbanization displayed an even stronger effect on waste generation. Other research works extended this examination and confirmed explicitly the existence of a turning point between income and waste. Arbulú et al. (2015) explored the effects of tourism (notably, expenditure per tourist) on MSW generation in 16 EU countries (including Denmark) over the period 1997–2010. The authors provided tools for tourism management policies and supported the existence of the EKC curve between MSW and income.

However, other studies failed to confirm the existence of the EKC between waste and income. Cole et al. (1997) collected data on 13 OECD

countries (including Denmark) to examine the relationship between per capita income and a wide range of environmental indicators (nitrogen dioxide, carbon dioxide, methane, and municipal waste). Results of the panel analysis failed to support the EKC relationship, indicating no existing turning point. This is in line with Mazzanti and Zoboli (2005) who considered 18 EU countries (including Denmark) and examined the waste-income relationship over the period 1995–2000 but rejected the EKC. Subsequently, Mazzanti (2008) estimated waste elasticities with respect to income for 15 EU countries (including Denmark). Exploiting data over the period 1997–2001, results rejected the existence of hypothetical turning point among variables. Overall, Mazzanti and Zoboli (2008) extended their analysis to 25 EU countries (including Denmark) and found no de-linking process between final consumption household expenditure and waste generation per capita, although elasticity to income drivers appeared lower than in their previous study. Baalbaki and Marrouch (2020) examined the relationship between MSW and GDP per capita for 33 OECD countries (including Denmark). The authors employed Wang (2013)'s flexible polynomial model with data spanning the 1995–2012 period. Despite evidence of a downward sloping relationship among variables, the results rejected the EKC hypothesis. Table 2 summarizes the main information of this literature.

## 2.3. Green logistics indicators-environmental degradation nexus studies and waste management within circular business models

Logistic management is a crucial part of the supply chain management. This refers to a set of integrated actions improving inventory storage, material handling, freight transport and information processing (Martel and Klibi, 2016). Even though logistics is known as a significant contributor to economic growth, its interlinkages with environmental degradation remain ambiguous and under-estimated. The seminal study from Khan et al. (2017) shed light on an original prospect: carbon emissions may also affect adversely economic growth. As awareness becomes stronger, customers are more conscious regarding green products and sustainability, with governments being more aggressive to implement environmental policies. Interestingly, customer pressure can impact the firm's adoption of green supply chain management (GSCM) practices (Khan et al., 2018). Hence, specific literature linking green logistic operations and economic and environmental indicators have emerged. Khan et al. (2018) considered 43 different economies (including Denmark) and claimed that logistics operations deplete energy and fossil fuel, while the amount of fossil fuel and non-green energy sources has a substantial adverse impact on the sustainability of the atmosphere. With a special focus on emerging Asian countries, Khan et al. (2019) showed that logistics operations – especially the efficiency of customs clearance processes, the quality of logistics services, and trade-related infrastructure – positively impact per capita income, value-added manufacturing, and trade openness. Nevertheless, greater logistics activities are negatively associated with social and environmental issues, including climate change, global warming, carbon pollution and ozone poisoning.

<sup>14</sup> By contrast, some single-country analyses on neighbouring countries are available. For a specific assessment in Switzerland, see Jaligot and Chenal (2018) and Magazzino et al. (2020a). Evidence for the US case are provided in Lee et al. (2016).

**Table 2**

Summary of previous studies on the relationship between waste and GDP including Denmark.  
Source: our elaborations.

Author(s)	Countries	Sample period	Methodology	Waste/GDP data	EKC for Denmark
Cole et al. (1997)	13 OECD countries	1975–1990	FE	Municipal solid waste generation/GDP per capita,	No
Johnstone and Labonne (2004)	30 OECD countries	1980–2000	FE	Municipal solid waste generation per capita/GDP per capita	–
Mazzanti and Zoboli (2005)	18 EU countries	1995–2000	RE, FE	Municipal solid waste generation per capita/GDP per capita	No
Karousakis (2006)	30 OECD countries	1980–2000	RE, FE	Municipal solid waste generation/GDP per capita	–
Mazzanti (2008)	15 EU countries/28 EU countries	1997–2001/1995–2000	FE	Waste generation per capita/GDP per capita	No/No
Mazzanti and Zoboli (2008)	25 EU countries	1995–2005	FE	Municipal solid waste generation per capita/Final consumption expenditure of households	No
Arbulú et al. (2015)	16 EU countries	1997–2010	FE	Municipal solid waste generation per capita/GDP per capita	Yes
Baalbaki and Marrouch (2020)	33 OECD countries	1995–2012	FE	Municipal solid waste generation per capita/GDP per capita	No

Notes: FE: fixed effects model. RE: random effects model.

Far from being a coincidence, the nature of MSW disposal plays a leading role in the path to sustainability. This allows for sharp resources preservation and environmental footprint reduction, circular business models coincide with waste treatment operations (OECD, 2020). Thus, interesting literature is emerging, underlining the potential of waste recovery for the circular economy. Nonetheless, D'Adamo et al. (2019) argued that the economic feasibility of such a model is confirmed for a few scenarios only in Italy. Focusing on the transport sector, the authors concluded that the use of green gas is capable of reducing GHG emissions, but the economic cost of the environmental externality (i.e., 226 €/certificates of emission of biofuel in consumption (CIC)) remains lower than the value released by the current Italian decree (i.e., 375 €/CIC). Van Fan et al. (2020) proposed an integrated design of waste management systems under a circular environment using *P*-graph (bipartite graphical optimisation tool). The authors showed that each ton of MSW processed could avoid 411 kg of GHG emissions (expressed in CO<sub>2</sub> equivalent), besides, it could achieve an estimated profit of 42 €/ton of MSW treated. Looking at the case of Croatia, Luttenberger (2020) built a relevant review on national waste policies, and provided careful measures to strengthen Croatia's path towards a circular economy.

Based on this review, an in-depth assessment on the Danish case may fill a crucial gap in the literature, while presenting accurate findings useful for researchers and policymakers. Hence, this paper investigates the causal relationship between per capita GDP, MSW generation per capita, and GHG emissions from the waste sector in Denmark. Following Magazzino et al. (2020a), a novel time-series analysis coupled with a Machine Learning approach is utilized.

### 3. Data collection and empirical strategy

#### 3.1. Data collection

To implement our model, we derived the following data for Denmark: Total Municipal Solid Waste Generation (*TMWG*) is expressed in kilograms per capita; per capita GDP (*GDPp*) is expressed in Purchasing Power Parity (PPP) constant 2017 international \$; GHG emissions from the waste sector are expressed in thousand tonnes of CO<sub>2</sub> equivalent (*GGWS*). As a proxy for urbanization, we use urban population, expressed in % of total population (*Urban*). *TMWG* and *GGWS* are taken from the OECD Environment Statistics database.<sup>15</sup> *GDPp* and *Urban* data are derived from the World Development Indicators database.<sup>16</sup> According to the OECD (2015), MSW indicator corresponds

<sup>15</sup> Per capita MSW generation and GHG emissions from the waste sector data are available at: <https://data.oecd.org/environment.htm>.

<sup>16</sup> Per capita GDP and urban population data are available at: <https://databank.worldbank.org/source/world-development-indicators>.

to the total waste collected by or on behalf of the municipalities. It incorporates waste originating from households, and small commercial activities. GHG emissions are constituted of carbon dioxide (CO<sub>2</sub> from energy use and industrial processes) and methane emissions that are produced by the waste sector (OECD, 2019b). The data cover the period 1994–2018. The choice of the starting period was constrained by waste and GHG emissions data availability, often missing or unavailable before 1995 for most of the advanced economies.

#### 3.2. Empirical methodology

The causality relationship expressed in econometric modeling is now tested through the ANNs approach. According to Pearl (2009) and Kocaoglu et al. (2017), we develop Feed-forward Neural Networks as a Structural Causal Models (SCMs), to verify how (in a predictive way) *TMWG*, *GDPp*, and *Urban* cause *GGWS* in Denmark.

ANNs are made up of elementary computational units (neurons) known as Processing Units (PU). Neurons are combined according to different architectures: for example, they can be organized in layers (multi-layer network), or they can have a topology in which each neuron is connected to all the others (fully connected network). We mainly refer to layered networks, consisting of the input layer, with *n* neurons equal to the number of network inputs; the hidden layer, with one or more hidden (or intermediate) layers consisting of *m* neurons; the output layer, with *p* neurons equal to the number of desired outputs. The connection methods allow us to distinguish between two types of architectures. In feedback architectures, the presence of connections between neurons of the same layer or between neurons of the previous layer creates a feedback connection. In feed-forward architectures, the connections between the levels are interconnected and do not generate minimum levels. Thus, the signal is transmitted only to neurons belonging to the next layer. McCulloch and Pitts (1943) proposed the representation of the ANNs reported in Fig. 1.

Each neuron receives *n* input signals from the other neurons (the vector *x*), through connections of intensity *w* (synaptic weights). The input signals are consolidated into a postsynaptic potential *y*, which is the weighted sum of the inputs. The sum function, thus, calculates the activation value, which is then transformed into the output *F(y)* by an appropriate transfer or activation function. Neurons in the input layer have no input. Their activation status corresponds to the data input to the network. They do not perform any calculation, and the activation function transfers the input value to the network without changing it. The operational capacity of a network, i.e. its knowledge, is contained in the synapses, i.e. the weights of the input connections of each neuron. The latter assumes the correct values thanks to training. The NNs are not directly programmed but explicitly trained, through a learning algorithm to solve a given task, with a process that leads to learning through

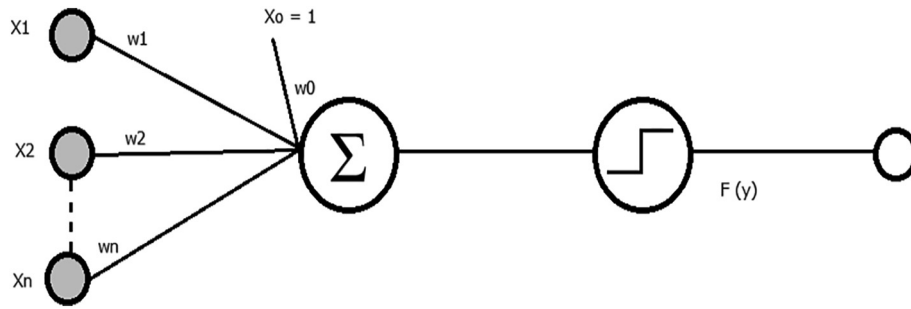


Fig. 1. A simple ANNs scheme.

experience. There are at least three types of learning: 1) supervised, 2) unsupervised, and 3) reinforcement. In the case of unsupervised learning, the network is trained only on an input set, without providing the corresponding output set. For supervised learning, however, it is necessary to identify a set of examples consisting of appropriate samples of the inputs and the corresponding outputs to be presented to the network, so that it learns to represent them. Finally, reinforcement learning is used in cases where it is not possible to specify input-output patterns for supervised learning systems. Reinforcement is provided to the system, which interprets it as a positive/negative signal on its behaviour, adjusting the parameters accordingly. The set of configurations used for learning the network constitutes the learning set, called the training set. Basically, we adopted an empirical strategy similar to Magazzino et al. (2020a, 2020b, 2020c), and Mele and Magazzino (2020).

In the following analysis, we consider more complex ANNs than the one in Fig. 2. Our ANN design has a multilayer structure (feed-forward multilayer, multilayer perceptron), and it is defined by  $M$  input nodes, lacking the capacity for processing, associated with inputs  $x_i \in R$ ; a set of neurons organized in  $L \geq 2$  layers, of which  $L - 1$  hidden layers and an exit layer, which provides the outputs network  $y_j$ ; a set of oriented and weighted arches that establish connections. The functions that represent the ANNs can be expressed as:

$$a_j = \sum_{i=1}^M w_{j,i}x_i - \theta_j \tag{1}$$

$$z_j = \psi(a_j) \tag{2}$$

$$j = 1, \dots, N \tag{3}$$

$$y = \sum_{j=1}^N v_j z_j = \sum_{j=1}^N v_j \psi \left( \sum_{i=1}^M w_{j,i}x_i - \theta_j \right) = \sum_{j=1}^N v_j \psi(w_j^T x - \theta_j) \tag{4}$$

where:

$x_i$ :  $i$ -th input/s;

$w_{j,i}$ : weight of the connection between the input  $i$  and the hidden neuron  $j$ ;

$\theta_j$ : hidden neuron threshold  $j$ ;

$v_j$ : weight of the connection between the neuron hidden  $j$  and the output neuron;

$\psi$ : activation function of the neurons of the hidden layer;

$z_j$ : hidden neuron output  $j$ ;

$a_j$ : combination of signals input to the hidden neuron  $j$ ;

$y$ : target

$w_j = (w_{j1}, \dots, w_{jM})^T$ .

The activation function  $\psi$  is usually supposed to be differentiable and sigmoidal. We can use two types of functions. The logistics function:

$$\psi_c(t) = \frac{1}{1 + e^{-ct}}, c > 0 \tag{5}$$

or the hyperbolic tangent function:

$$\psi_c(t) = \tanh\left(\frac{t}{2}\right) = \frac{1 - e^{-t}}{1 + e^{-t}}. \tag{6}$$

Once the logical process for our ANNs has been constructed, we can use the same dataset of the time-series analysis. However, since the ANNs require an extensive dataset, we have also generated the first-differences (d) and the logarithm (ln) of the series. This procedure allows us to grasp the variation between the data of the same variable in a context, that of ML, in which the time-series loses importance. Our algorithm, constructed through the extension of the Oryx protocol, use a combination of data equal to 495948561.<sup>17</sup> They represent all the possible input-target combinations necessary to generate the neural processing process that generates the final target. Subsequently, after building the neural process, we will proceed by testing the results obtained through the latest testing techniques on NN models.

After applying the ANN algorithm, we access the hypothesis that Denmark is on the verge of achieving a circular economy—a situation where waste and pollution is eliminated through recycling, reusing and regeneration of natural resource capital. To test this, we utilize regression to examine the nexus, variable importance of projection to investigate the impact of income level, waste generation and urban population on GHG emissions from waste sector. We finally apply the Breitung-Candelon Spectral Granger-causality to investigate the

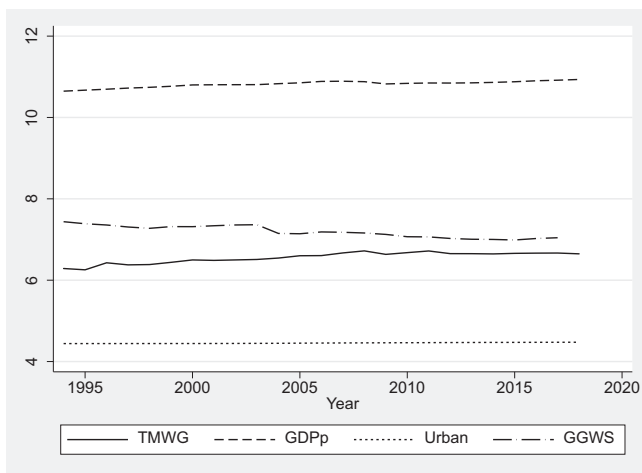


Fig. 2. Municipal solid waste generation, real per capita GDP, urban population, and greenhouse gas from the waste sector in Denmark (log-scale, 1994–2018). Data on municipal solid waste generation are expressed in kilograms per capita; per capita GDP is expressed in Purchasing Power Parity (PPP) constant 2017 international \$; urban population is expressed in percentage (%) of the total population; Greenhouse gas emissions from the waste sector are expressed in thousand tonnes of CO<sub>2</sub> equivalent. Sources: OECD and WDI data.

<sup>17</sup> Result =  $DR_{n,k}$ . In this case,  $k$ , a positive integer, can also be greater than or equal to  $n$ .

**Table 3**  
Descriptive statistics.

Variable	Mean	Median	SD	Skewness	Kurtosis	Range	IQR	10-Trim
TMWG	6.5571	6.6047	0.1339	-0.7705	2.5087	0.4654	0.1726	6.573
GDPp	10.8202	10.8385	0.0760	-0.7587	2.7957	0.2879	0.0783	10.830
Urban	4.4563	4.4555	0.0122	0.2274	1.4909	0.0338	0.0237	4.456
GGWS	7.1930	7.1696	0.1455	0.0842	1.5604	0.4498	0.2740	7.191

Notes: SD: standard deviation; IQR: inter-quartile range; 10-Trim: 10% trimmed mean. Sources: our calculations on OECD and WDI data.

direction of causality in a frequency domain—useful for policy formulation. The empirical specification of the regression model can be expressed as:

$$y_t = \delta_0 + \beta x_t + \varepsilon_t \tag{7}$$

where  $y_t$  denotes the greenhouse gas from waste sector,  $\delta_0$  is the constant,  $x_t$  represents the regressors namely total Municipal waste generation, income level and urban population.  $\beta$  is the parameter to be estimated and  $\varepsilon_t$  is the error term in time  $t$ .

Following the specification expounded in Sarkodie and Adom (2018), the variable importance of projection can be expressed as:

$$VIP_w = \sqrt{\frac{\sum_{w=1}^u S_v \left[ \frac{z}{z_{vw}} \right]}{\sum_{v=1}^u S_v}} \tag{8}$$

where  $VIP_w$  denotes the variable importance of projection,  $N_0$  is the number of independent variables,  $u$  is the number of dimensions extracted using partial least squares algorithm,  $Z_{vw}$  represents the weight of the variable importance of projection of input variable  $w$  and the number of dimensions  $v$  explained by partial least squares algorithm, and  $S_v$  denotes the explained sum of squares. The  $VIP_w$  algorithm is critical to explaining the influence of total Municipal waste generation, income level and urban population in predicting the observed changes in GHG emissions attributed to the waste sector in Denmark.

Contrary to the traditional Granger causality test employed in the extant literature, we adopt the Breitung-Candelon Spectral Granger-causality algorithm that has an advantage in the prediction of causal-effects along a specific time-frequency, useful for waste control policy formulation. Here, we follow the specification presented in Breitung and Candelon (2006); Sarkodie (2020) to examine the direction of causality. For brevity, the generic specification is presented in a VAR equation as:

$$\ln x_t = \delta_1 \ln x_{t-1} + \dots + \delta_p \ln x_{t-p} + \partial_1 \ln y_{t-1} + \dots + \partial_p \ln y_{t-p} + \varepsilon_{1,t} \tag{9}$$

where  $x_t|y_t$  denotes the causal effect between  $\ln$ GHG and  $\ln$ UP;  $\ln$ GHG and  $\ln$ TMWG;  $\ln$ GHG and  $\ln$ RPCGDP;  $\ln$ TMWG and  $\ln$ RPCGDP; and  $\ln$ TMWG and  $\ln$ UP.  $\ln$  is the logarithmic transformation of the data series to control for heteroskedasticity,  $\delta|\partial$  are parameters to be estimated,  $t$  is the time period,  $\varepsilon_{1,t}$  is the error term and  $p$  denotes the lags. To obtain an optimal lag-order for the frequency domain causality test, we utilize the pre-estimation syntax for vector autoregressive models that employ multiple reporting and selection indicators such as Akaike information criterion (AIC), final prediction error (FPE), Hannan & Quinn information criterion (HQIC) and Schwarz Bayesian information criterion (SBIC). The resulting optimal lags selected for subsequent analysis are presented in Appendix B. The null hypothesis of Eq. (9) is based on a bivariate framework technique  $[M_{y_t \rightarrow x_t}(\omega) = 0]$  that  $y_t$  does not predict  $x_t$  at a specific frequency  $\omega$ . Thus, a rejection of the null hypothesis at  $p$ -value  $< 0.05$  stipulates  $y_t$  predicts  $x_t$  in the frequency domain.

#### 4. Empirical results

As a preliminary check, descriptive statistics are presented in Table 3. All variables except greenhouse gas exhibit a negative skewness, which indicates that the tail on the left side of the distribution is longer or wider.

In Fig. 2, we show the evolution of the logarithmic transformations for the analyzed series.

In Table 4 we report the results of two different time-series tests on unit root to determine the order of integration of the variables.

In Table 4, it can be observed that the four selected series are non-stationary at levels. The null hypothesis ( $H_0$ ) of non-stationarity is rejected, in general.

Table 5 represents the summary of the dataset used in the Oryx processing of our ANNs. The variables used are 12, of which 11 represent the input process, and 1 is the generated target.

In Fig. 3, we report the behaviour of the instances through a pie chart elaborated by the protocol.

**Table 4**  
Results for unit roots and stationarity tests.

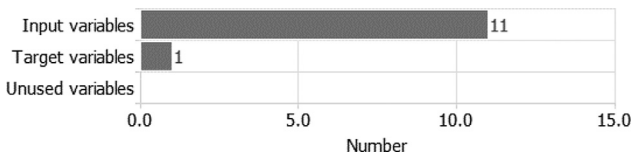
Variable	Unit root and stationarity tests			
	NP Intercept	NP Intercept and trend	ERS Intercept	ERS Intercept and trend
TMWG	-0.9738 (-8.1000)	-6.1393 (-17.3000)	-1.1827 (-1.9557)	-2.0641 (-3.1900)
GDPp	0.9199 (-8.1000)	-7.1426 (-17.3000)	-0.4621 (-1.9557)	-2.0657 (-3.1900)
Urban	0.3059 (-8.1000)	-94.2148*** (-17.3000)	-1.6743* (-1.9557)	-2.8326 (-3.1900)
GGWS	-0.5767 (-8.1000)	-8.7074 (-17.3000)	-0.8634 (-1.9557)	-2.6467 (-3.1900)

Notes: NP: Ng-Perron Modified test; ERS: Elliott-Rothenberg-Stock DF-GLS test. When it is required, the lag length is chosen according to the Schwarz Bayesian Information Criterion (SBIC). For NP tests  $Mza$  statistics are reported; for ERS tests  $t$  statistics are reported. 5% Critical Values are given in parentheses.

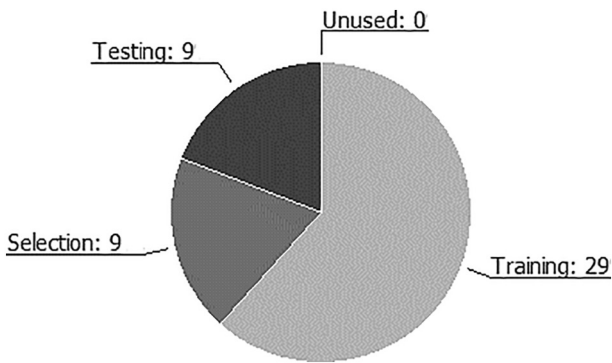
\*\*\*  $p < 0.01$ .  
\*  $p < 0.10$ .

**Table 5**

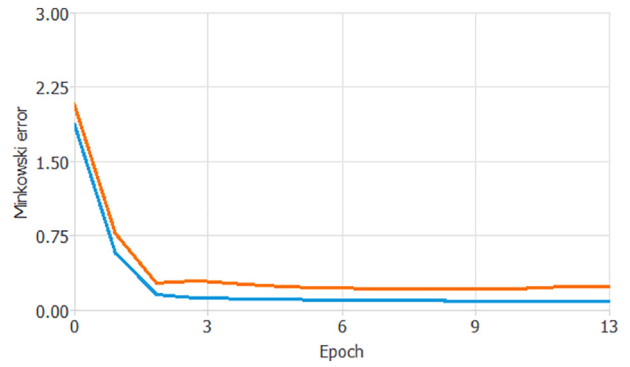
Variables bars chart.  
Source: our elaborations.



The instances of the ML process are equal to 47 whereas those representing the training are 29 (61.7%). This result underlines how, compared to a choice of  $n$  projects, our model chose 29 models out of 47 potentials. They are the ones that best suit the target. The result confirms the goodness of the choice. The selection requests are 9 (19%), therefore, the instances selected the best possible ANNs process generated target, allowing us to continue the processing. The instances are 9 (19%) and represents the choice of numerous training models. Since it is the same and never less than the selection instances, this reinforces the previous findings. Finally, the number of unused instances is 0 (0%), confirming the goodness of the model. In fact, no anomalous values – which would have invalidated the results – were generated.



**Fig. 3.** Instances pie chart.  
Source: our elaborations.



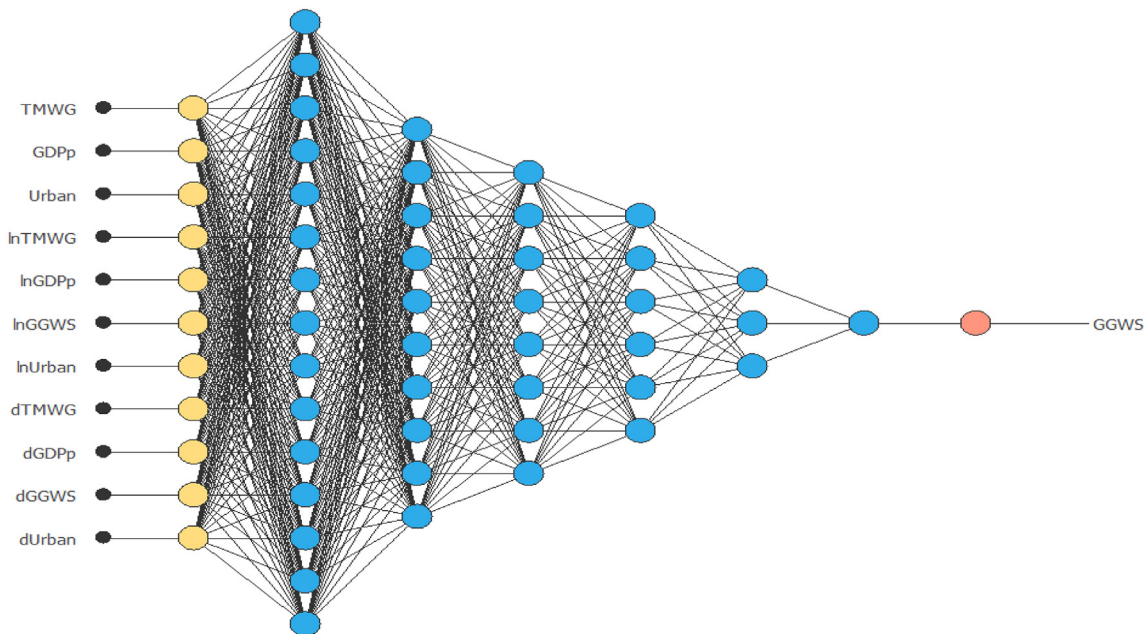
**Fig. 5.** Quasi-Newton method algorithm errors history.  
Source: our elaborations.

After observing the processing behaviour of the datasets in ML algorithm, we analyze the result of the Back-Propagation Neural Networks (BPNNs) presented in Fig. 4. It represents the result of 96 possible constructions of the ANNs. We chose the one that had the best neural transmission in the Mean Square Error (MSE) test (0.0012).

The graphical elaboration on the ANNs generated in Oryx with NN Design is depicted in Fig. 4. The architecture of the ANNs reveals a complexity, represented by hidden neurons, of 15: 10: 8: 6: 3. The distribution of the ANNs is of the hyperbolic tangent type. The yellow circles represent the scaling neurons, the blue circles the perceptron neurons, and the red one the unscaling neurons. The number of inputs is 11, and the number of outputs is 1. Each combination of the inputs generated the variation of the GGWS, in a process in which there were no anomalous values. Therefore, the graph of ANNs can be read as the  $n$  combinations of inputs that generate a variation of the target through a hyperbolic combination, with a linear result about the target.

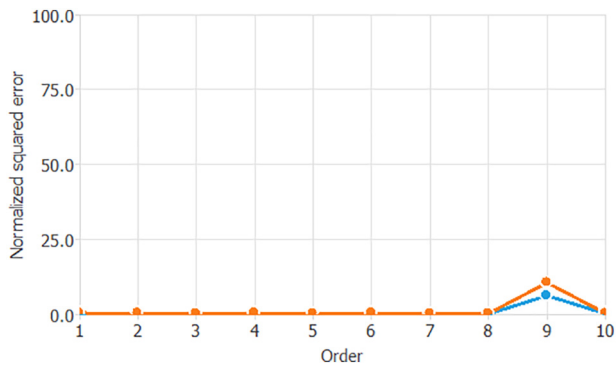
After building the ANNs, we proceed through numerous tests that may validate the model. These tests represent the only way for the operator to know the probability that there is a better algorithm different from the one chosen in the initial phase.

The first phase of the model algorithm's goodness begins with the analysis of the Perform Training. The Quasi-Newton method is used

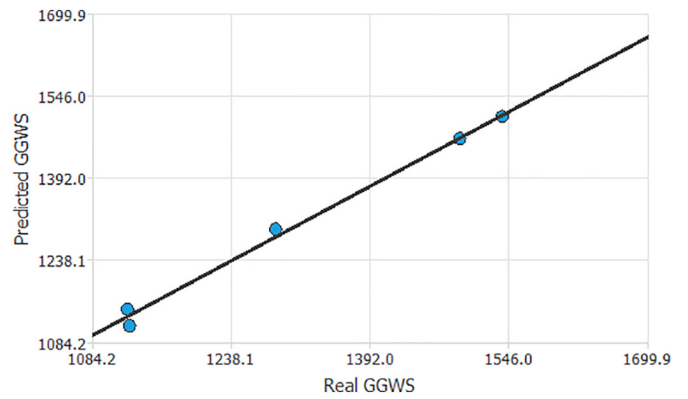


**Fig. 4.** ANNs results.  
Source: our elaborations in NN Design Software on Oryx.





**Fig. 6.** Incremental order error plot test. Source: our elaborations.



**Fig. 8.** Predictive linear regression test. Source: our elaboration.

here for training. It is based on Newton’s method, but it does not require calculation of second derivatives. Instead, the Quasi-Newton method computes an approximation of the inverse Hessian at each iteration of the algorithm, by only using gradient information.

Fig. 5 shows the training and selection errors in each iteration. The blue line represents the training error, while the orange one is the selection error. The initial value of the training error is 1.75489, and its final value after 13 epochs is 0.045617. The initial value of the selection error is 1.84954, and its final value after 13 epochs is 0.15654. The downward trend of both error assessments highlights how our strategy turned out to be ideal for the ANNs elaboration process. Next, we run the Performed Order Selection (POS) test. The best selection is achieved by using a model whose complexity is the most appropriate to produce an adequate fit of the data. The order selection algorithm is responsible for finding the optimal number of neurons in the network. Incremental order is used here as an order selection algorithm in the model selection. Fig. 6 shows the error’s history for the different subsets during the incremental order selection process. The blue line shows the training error, while the orange line symbolizes the selection error.

Both the training error and the selection error decrease with increasing order. Only at order number 9, we observe a minimal increase in the output error. In this level, the training error is only 2.8%, while the selection error is 6%. This result highlights the presence of a better-hidden architecture. It presents even lower algorithm errors than our initial architecture. Thus, following the ML process in Fig. 7, we elaborated the final architecture of the ANN.

Fig. 7 represents the result of our elaboration considering the findings achieved with the POS test. The number of inputs is 3, and the

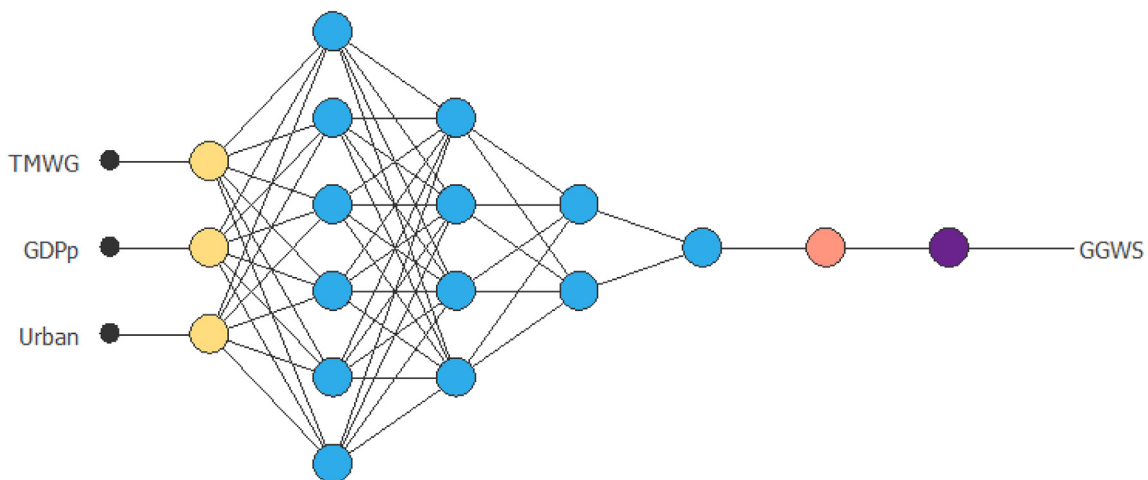
number of outputs is 1. The complexity, represented by the numbers of hidden neurons, is 6:4:2. Therefore, compared to Fig. 4, this ANNs presents an automatic choice that has reduced the third hidden layer of a neuron. Afterwards, we test the final architecture through different operations. A standard method to test the loss of a model is to perform a linear regression analysis between the scaled ANNs outputs and the corresponding targets for an independent testing subset.

As observed in Fig. 8, the prediction line (with respect to the target, GGWS) perfectly confirms the goodness of the elaboration about the algorithm on the final architecture. As required by theory, the slope of the straight line records a value close to unity (0.908); the correlation value is very high (0.997).

Finally, we proceed with the ANNs error test (Table G) to ascertain the goodness of fit test of this algorithm. It analyzes the result of four different errors concerning the three main instances of the NN model.

Table 6 analyzes four possible scenarios of prediction errors concerning training, selection, and testing. For ANNs theory, values from training to testing should be gradually lower and lower than unity. The results obtained fully confirm the theory of this test. All the errors of the three main components of the ANNs are less than one. Besides, it is clear how the training errors are lower than the selection errors, which are lower than the testing errors. This test confirms how the latest architecture of the ANNs respects the hypothesis of the slightest prediction error and that our generated target is correctly affected by the influence of the numerous combinations between the inputs.

We complemented the ANN algorithm using time series-based regression in a bivariate framework to examine the influence of the



**Fig. 7.** Final architecture of ANNs results. Source: our elaborations in NN Design Software on Oryx.

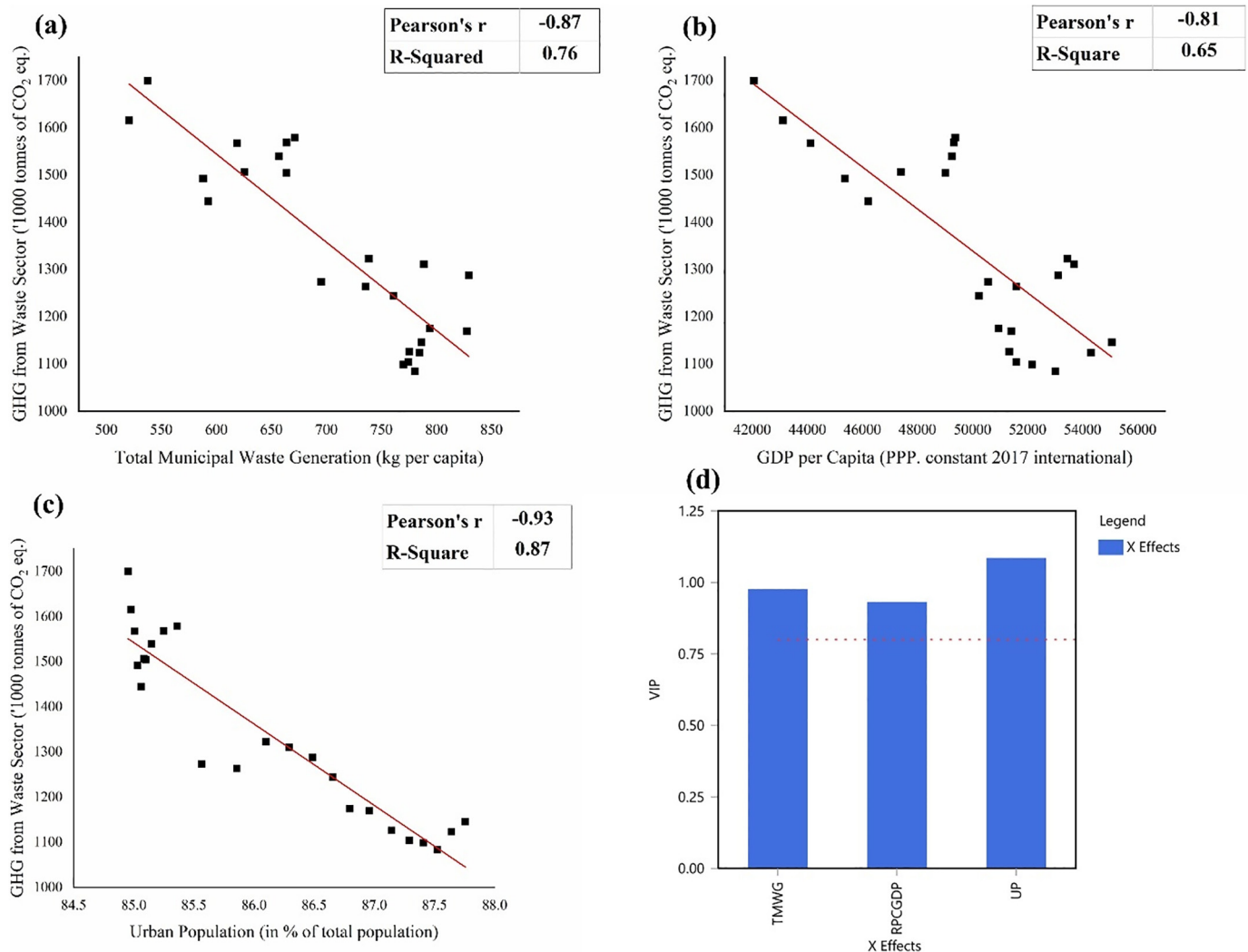
**Table 6**  
ANNs error test.  
Source: our elaborations.

	Training	Selection	Testing
Sum squared error	0.000	0.005	0.021
Mean squared error	0.000	0.001	0.004
Root mean squared error	0.001	0.033	0.064
Minkowski error	0.000	0.026	0.066

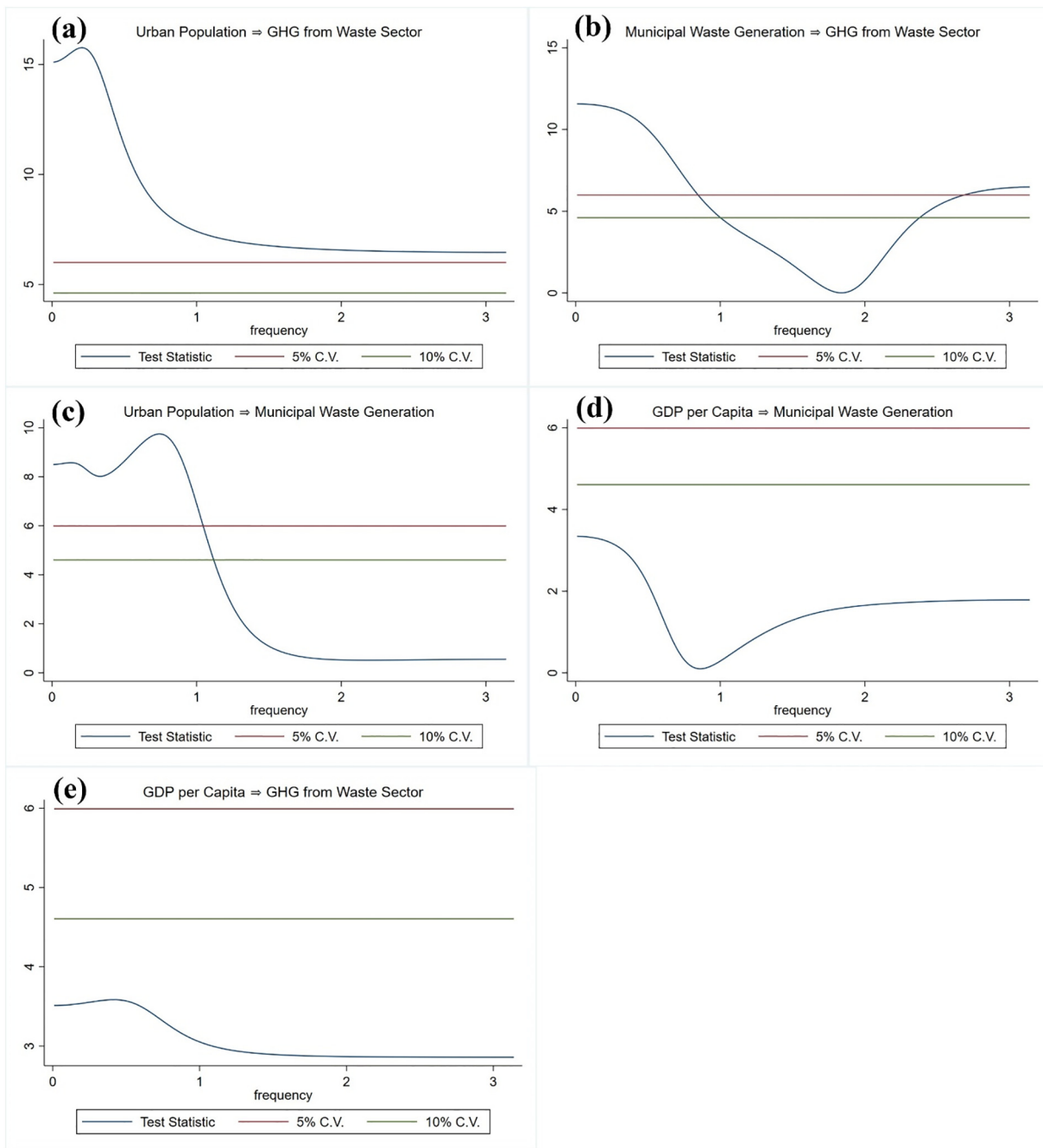
predictors on GHG from waste sector. It can be observed in Fig. 9 that total municipal waste generation, income level and urban population have a negative relationship with waste sector attributed GHG, with a predictive power between 65 and 87% and strength of correlation between  $-0.81$  to  $-0.93$ . This confirms the hypothesis that Denmark is on the verge of achieving a circular economy—meaning that, while urban population increases with growth in income and levels of municipal waste generated, waste sector attributed GHG emissions decline periodically. In terms of variable influence in reducing GHG emissions, it can be observed from the variable importance of projection plot that while urban population is highly influential ( $VIP > 1$ ) municipal waste generation and income level are moderately influential ( $0.8 < VIP < 1$ ), thus, corroborating both estimated Pearson's correlation and R-square.

Evidence from Breitung-Candelon Spectral Granger-causality test in Fig. 10 reveals that the null hypothesis of no predictability from urban population to GHG from waste sector and municipal waste generation to GHG from waste sector is rejected at 5% significance level. We observe that among all odds, urban population has a strong unidirectional causality along the entire frequency range compared to municipal waste generation that turns insignificant between  $\omega \in [1, 2.5]$  frequency range. In contrast, we find no causality from urban population to municipal waste generation, income level to municipal waste generation, and income level to GHG from waste sector. From a policy perspective, it appears that urbanization has a mitigation effect on waste sector attributed GHG emissions which might perhaps be due to Denmark's urban waste management options that underscore recycling, reusing and efficient conversion of waste-to-energy. Previously, waste generation in Denmark had strong positive monotonic associated with economic development and emissions, which supported the traditional linear economy (Mst.dk, 2015). However, our empirical estimation confirms a drift from linear economy to circular economy. This implies that the Danish government is implementing conservation and management policies that favour environmental sustainability.

Finally, we report the result of the predictive causality effect from the inputs to the target. This result highlights three possible variations of the target: position, velocity, and acceleration. The three variables presented in Table 7 cause a predictive variation of the target with



**Fig. 9.** Nexus between GHG from waster sector and (a) municipal waste generation (b) income level (c) urban population. (d) variable importance of projection (VIP) for sampled series. **Legend:** UP: Urban population; TMWG: Total Municipal Waste Management; RPCGDP: per capita GDP.



**Fig. 10.** Breitung-Candelon Spectral Granger-causality showing (a) Urban population → GHG from waste sector (b) municipal waste generation → GHG from waste sector (c) urban population → Municipal waste generation (d) GDP per Capita → Municipal waste generation (e) GDP per Capita → GHG from waste sector.

different speed and acceleration levels. We can note that the emissions from waste are accelerated by the quantity of municipal solid waste products in the country under study. However, we note that this acceleration would represent a linear transition from urban growth to the

change in per capita GDP towards waste production. We can also interpret these results by weighing the role of the change in per capita GDP compared to the urban increase. The variable of which represents economic growth in a high-income country such as Denmark, generates a more significant effect in the production of waste and emissions, compared to a hypothetical growth of the population. If the transition between speed and acceleration towards the target passes from economic growth to waste production, the increase in the demand for goods and services of the population is directly a consequence of the emissions (target). Besides, the changes in target acceleration is predictively caused by the change in speed and acceleration of the Municipal solid waste. Therefore, a separate waste collection policy would generate a change in the decrease in the acceleration of the target and, thus, in emissions. The effects of such an economic waste management policy

**Table 7**  
Inputs on the target.  
Source: our elaborations.

	Position	Velocity	Acceleration
TMWG	0.4	0.8	0.9
GDPp	0.3	0.7	0.8
Urban	0.2	0.4	0.7

would have a recordable economic impact on the acceleration of GDP. Different waste collection companies, as is happening in Denmark, can adopt policies of opening up to the economic market. By purchasing the raw material produced by users (plastic, metal, glass), the materials could be used in a (re)transformation cycle. Therefore, they will create new products in the economic system. In this way, users are not pushed and throw waste onto the street for which they are remunerated.

Finally, we tested our NN algorithm in the process that generates different alternative models with the Optimization Test in Machine Learning (OPTML). This experiment created 70 different transformations of

the dataset and developed 30 different algorithms (including ours) capable of predicting a causal link between the variables. The process (Fig. 11), which lasted 4 min and 36 s, found 16 candidates for the solution of the experiment. Of these 16 models, only 8 were selected. Of the 8 models selected, the system showed the result of the comparative R-squared. As observed from the results, our algorithm (Back Propagation Neural Networks) has a relatively large R-squared (0.738).

The optimization test also took into consideration hypothetical econometric and statistical models. However, they turned out to be less suitable than alternative models like ours or the boosted trees.

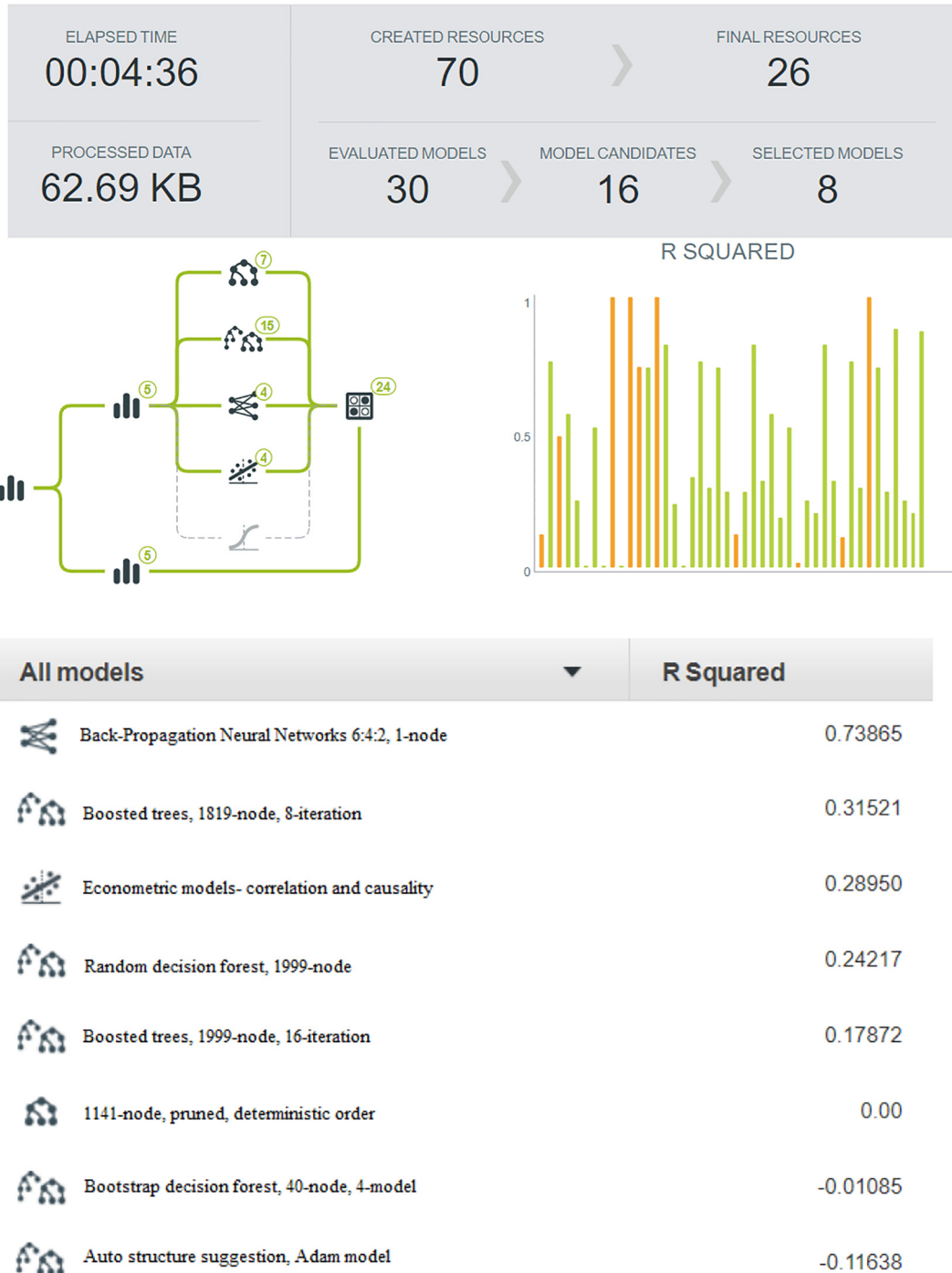


Fig. 11. Optimization test in machine learning results. (Source: our elaborations in BIG protocol on the Apache Maven 3.2.5 software.)

Therefore, we can conclude that there is no algorithm better than the one used in this study.

## 5. Conclusion and policy implications

This paper presented the first evidence on the causal relationship between MSW generation per capita, per capita GDP, urbanization, and GHG emissions from the waste sector in Denmark. We exploited the most recent and available data period (1994–2018) and a very current estimate model based on Artificial Neural Networks and Breitung-Candelon Spectral Granger-causality. In contrast to traditional statistic or econometric techniques, we employed sophisticated mathematical methods since they better penetrate the laws of the “environment”. In fact, after processing the data through numerous combinations in the so-called learning phase, our Neural Network proposed a linearization of the problem, which we solved using a mathematical formula that binds the different ones together variables. Our Neural Network required a double construction to choose autonomously through the Incremental Order Test, the best “input neurons” capable of generating the final signal to the selected target. This procedure, confirmed by the most sophisticated Machine Learning tests, allowed us to obtain a neural network from which we observed how GHG emissions from the waste sector in Denmark undergo variations based on the economic trend of the Total Municipal Solid Waste Generation, from the proxy for urbanization and GDP per capita. The results showed how the variance of per capita GDP represents the variable that can accelerate emissions from waste.

Our results obtained from the analysis of neural networks could be interpreted as a coupling–decoupling relationship between economic growth and management of waste that causes harmful emissions. Indeed, a greater wealth that certainly translates into a higher amount of waste generated is associated with a reduction of emissions from the waste sector. Similarly, our time series model corroborated these findings and found a significant negative monotonic relationship between waste sector GHG emissions, income, urbanization, and municipal waste generation. In line with that, the Breitung-Candelon Spectral Granger-causality supports the existence of a unidirectional causal link from urban population and municipal waste to waste emissions. Bringing high value information, our time-series findings confirmed logically the results of the machine learning approach. Hence, an accurate interpretation of them is required to design consistent policy measures.

In a given economy, the amount of waste generated is effectively linked to the level of income, and thus wealth. However, it has also been shown that such relation can be non-linear. As income grows over time, recycling, composting, and incinerating processes may replace standard landfills. As a matter of fact, a de-linking relationship among wealth and waste may emerge, with major positive effects on the environmental quality. Since Denmark displays one of the world's highest income per capita, this economy may have reached a turning point of economic development after which, wealth enhances waste generation while it reduces emissions from the waste sector. Accordingly, it is a relevant perspective for policy making at a national scale — as the nation-specific waste situation is a crucial issue in Europe. First, reducing the costs and improving the effectiveness of major waste treatment policies is necessary. This concerns phasing-out from landfill strategies, but also developing high-tech waste incineration and recycling processes across the Danish territory. Because the proportion of urban population is decidedly linked to waste generation and emissions in Denmark, specific attention should be drawn to densely populated areas, where waste management is at the heart of environmental concerns but also the core of solutions. Second, lowering the generation of waste at its source should explicitly be pursued, since strengthening the waste management in the post-production phase is not sufficient. Thus, waste policy efforts should focus on changing agents' behaviour and firms' decisions at the level of waste production. Otherwise, an increasing gap will emerge between the policy objective

(slowing down climate change and land use degradation in Denmark) and its effective implementation (uncontrolled polluting emissions from the Danish waste sector).

Opening to an international prospect, our results would represent policy advice based on a global policy that sees wealth as the solution to waste emissions. Obviously, investments in waste management are functions of the economic and social capacity of the country, but also on its willingness to achieve environmental targets. While logical for such an advanced economy like Denmark, other developing countries face chronic difficulties in managing waste because of a crucial lack of financial capacity and public infrastructures devoted to this issue. Therefore, future studies should examine the wealth-waste-emissions nexus in developing countries if data availability allows that. Since numerous urban areas display critical levels of untreated and polluting waste, researchers should identify the conditions under which a cutting-edge waste chain may be implemented in low- and middle- income countries. But first and foremost, promoting adequate waste management practices would substantially help turning these cities towards a sustainable path.

## CRedit authorship contribution statement

**Cosimo Magazzino:** Conceptualization, Data curation, Formal analysis, Methodology, Software, Validation, Visualization, Writing - review & editing. **Marco Mele:** Conceptualization, Writing - original draft. **Nicolas Schneider:** Conceptualization, Writing - original draft. **Samuel Asumadu Sarkodie:** Conceptualization, Formal analysis, Methodology, Software, Validation, Visualization, Writing - original draft, Writing - review & editing.

## Declaration of competing interest

The authors declare that they have no known competing financial interests or personal relationships that could have appeared to influence the work reported in this paper.

## Acknowledgement

Open Access funding provided by Nord University.

## Appendix A. Supplementary data

Supplementary data to this article can be found online at <https://doi.org/10.1016/j.scitotenv.2020.142510>.

## References

- Acaravci, A., Ozturk, I., 2010. On the relationship between energy consumption, CO<sub>2</sub> emissions and economic growth in Europe. *Energy* 35 (12), 5412–5420.
- Ali, S.M., Pervaiz, A., Afzal, B., Hamid, N., Yasmin, A., 2014. Open dumping of municipal solid waste and its hazardous impacts on soil and vegetation diversity at waste dumping sites of Islamabad city. *Journal of King Saud University – Science* 26, 59–65.
- Andersen, F.M., Larsen, H.V., 2012. FRIDA: a model for the generation and handling of solid waste in Denmark. *Resour. Conserv. Recycl.* 65, 47–56.
- Arbulú, I., Lozano, J., Rey-Maqueira, J., 2015. Tourism and solid waste generation in Europe: a panel data assessment of the environmental Kuznets curve. *Waste Manag.* 46, 628–636.
- Ayalon, O., Avnimelech, Y., Shechter, M., 2001. Solid waste treatment as a high-priority and low-cost alternative for greenhouse gas mitigation. *Environ. Manag.* 27 (5), 697–704.
- Baalbaki, R., Marrouch, W., 2020. Is there a garbage Kuznets curve? Evidence from OECD countries. *Econ. Bull.* 40 (2), 1049–1055.
- Baek, J., 2015. Environmental Kuznets curve for CO<sub>2</sub> emissions: the case of Arctic countries. *Energy Econ.* 50, 13–17.
- Barbier, E., 2011. The policy challenges for green economy and sustainable economic development. *Nat. Res. Forum* 233–245.
- Ben Jebli, M., Ben Youssef, S., Ozturk, I., 2013. The Environmental Kuznets Curve: The Role of Renewable and Non-renewable Energy Consumption and Trade Openness.

- Bernstad, A., Jansen, J., 2012. Review of comparative LCAs of food waste management systems—current status and potential improvements. *Waste Manag.* 32 (12), 2439–2455.
- Beşe, E., Kalayci, S., 2019. Environmental Kuznets curve (EKC): empirical relationship between economic growth, energy consumption, and CO<sub>2</sub> emissions: evidence from 3 developed countries. *Panoeconomicus* 1–26.
- Bilgili, F., Koçak, E., Bulut, Ü., 2016. The dynamic impact of renewable energy consumption on CO<sub>2</sub> emissions: a revisited environmental Kuznets curve approach. *Renew. Sust. Energy. Rev.* 54, 838–845.
- Bogner, J., Pipatti, R., Hashimoto, S., Diaz, C., Mareckova, K., Diaz, L., Kjeldsen, P., Monni, S., Faaij, A., Gao, Qingxian, Zhang, Tianzhu, Ahmed, Mohammed Abdelrafie, Sutarnihardja, R.T.M., Gregory, R., 2008. Mitigation of global greenhouse gas emissions from waste: conclusions and strategies from the intergovernmental panel on climate change (IPCC) fourth assessment report. Working group III (mitigation). *Waste Management Resources* 26, 11–32.
- Bowden, N., Payne, J.E., 2009. The causal relationship between US energy consumption and real output: a disaggregated analysis. *J. Policy Model* 31 (2), 180–188.
- Breitung, J., Candelon, B., 2006. Testing for short-and long-run causality: a frequency-domain approach. *J. Econ. 132* (2), 363–378.
- Chalak, A., Abou-Daheer, C., Chaaban, J., Abiad, M.G., 2016. The global economic and regulatory determinants of household food waste generation: a cross-country analysis. *Waste Manag.* 48, 418–422.
- Clarke, C., Williams, I.D., Turner, D.A., 2019. Evaluating the carbon footprint of WEEE management in the UK. *Resour. Conserv. Recycl.* 141, 465–473.
- Cole, M.A., Rayner, A.J., Bates, J.M., 1997. The environmental Kuznets curve: an empirical analysis. *Environ. Dev. Econ.* 2, 401–416.
- D'Adamo, I., Falcone, P.M., Ferella, F., 2019. A socio-economic analysis of biomethane in the transport sector: the case of Italy. *Waste Manag.* 95, 102–115.
- Das, S., Lee, S.H., Kumar, P., Kim, K.H., Lee, S.S., Bhattacharya, S.S., 2019. Solid waste management: scope and the challenge of sustainability. *J. Clean. Prod.* 228, 658–678.
- Dasgupta, S., Laplante, B., Wang, H., Wheeler, D., 2002. Confronting the environmental Kuznets curve. *J. Econ. Perspect.* 16 (1), 147–168.
- Dinda, S., 2004. Environmental Kuznets curve hypothesis: a survey. *Ecol. Econ.* 49 (4), 431–455.
- Domingos, H.A., Faria, A.M.D.M., Fuinhas, J.A., Marques, A.C., 2017. Renewable energy and greenhouse gas emissions from the waste sectors of European Union member states: a panel data analysis. *Environ. Sci. Pollut. Res.* 24 (23), 18770–18781.
- Dong, Y.H., An, A.K., Yan, Y.S., Yi, S., 2017. Hong Kong's greenhouse gas emissions from the waste sector and its projected changes by integrated waste management facilities. *J. Clean. Prod.* 149, 690–700.
- Farhani, S., Ben Rejeb, J., 2012. Energy consumption, economic growth and CO<sub>2</sub> emissions: evidence from panel data for MENA region. *International Journal of Energy Economics and Policy (IJEEP)* 2 (2), 71–81.
- Grossman, G.M., Krueger, A.B., 1991. Environmental impacts of a North American free trade agreement. *National Bureau of Economic Research Working Paper*, p. 3914.
- Halloran, A., Clement, J., Kornum, N., Bucatariu, C., Magid, J., 2014. Addressing food waste reduction in Denmark. *Food Policy* 49, 294–301.
- Intergovernmental Panel on Climate Change (IPCC), 2007. In: Metz, O.R.D.B., Bosch, P.R., Cambridge, L.A. Meyer (Eds.), *Contribution of Working Group III to the Fourth Assessment Report of the Intergovernmental Panel on Climate Change*. Cambridge University Press, Cambridge.
- Jaligot, R., Chenal, J., 2018. Decoupling municipal solid waste generation and economic growth in the canton of Vaud, Switzerland. *Resour. Conserv. Recycl.* 130, 260–266.
- Johnstone, N., Labonne, J., 2004. Generation of household solid waste in OECD countries: an empirical analysis using macroeconomic data. *Land Econ.* 80 (4), 529–538.
- Kannangara, M., Dua, R., Ahmadi, L., Bensebaa, F., 2018. Modeling and prediction of regional municipal solid waste generation and diversion in Canada using machine learning approaches. *Waste Manag.* 74, 3–15.
- Karousakis, K., 2007. Incentives to reduce GHG emissions from deforestation: lessons learned from Costa Rica and Mexico. *OECD Pap.* 7 (1), 1–50.
- Kasman, A., Duman, Y.S., 2015. CO<sub>2</sub> emissions, economic growth, energy consumption, trade and urbanization in new EU member and candidate countries: a panel data analysis. *Econ. Model.* 44, 97–103.
- Khan, S.A.R., Qianli, D., SongBo, W., Zaman, K., Zhang, Y., 2017. Environmental logistics performance indicators affecting per capita income and sectoral growth: evidence from a panel of selected global ranked logistics countries. *Environ. Sci. Pollut. Res.* 24 (2), 1518–1531.
- Khan, S.A.R., Zhang, Y., Anees, M., Golpîra, H., Lahmar, A., Qianli, D., 2018. Green supply chain management, economic growth and environment: a GMM based evidence. *J. Clean. Prod.* 185, 588–599.
- Khan, S.A.R., Sharif, A., Golpîra, H., Kumar, A., 2019. A green ideology in Asian emerging economies: from environmental policy and sustainable development. *Sustainable Development* 27 (6), 1063–1075 November/December.
- Kjær, Birgitte, Werge, Mads, 2010. *Forundersøgelse af madspild i Danmark. Miljøstyrelsen.*
- Kinnaman, T.C., Fullerton, D., 1997. Garbage and recycling in communities with curbside recycling and unit-based pricing. *National Bureau of Economic Research Working Paper*, p. 6021.
- Kocaoglu, M., Snyder, C., Dimakis, A.G., Vishwanath, S., 2017. CausalGAN: learning causal implicit generative models with adversarial training. *arXiv*.
- Kuznets, S., 1955. Economic growth and income inequality. *Am. Econ. Rev.* 45 (1), 1–28.
- Lee, S., Kim, J., Chong, W.K., 2016. The causes of the municipal solid waste and the greenhouse gas emissions from the waste sector in the United States. *Waste Manag.* 56, 593–599.
- Liu, C., Wu, X.W., 2011. Factors influencing municipal solid waste generation in China: a multiple statistical analysis study. *Waste Manag. Res.* 29 (4), 371–378.
- Lozano, S., Gutierrez, E., 2008. Non-parametric frontier approach to modelling the relationships among population, GDP, energy consumption and CO<sub>2</sub> emissions. *Ecol. Econ.* 66 (4), 687–699.
- Ludwig, C., Hellweg, S., Stucki, S., 2003. *Municipal Solid Waste Management*. Springer-Verlag, Berlin Heidelberg.
- Luttenberger, L.R., 2020. Waste management challenges in transition to circular economy – case of Croatia. *J. Clean. Prod.* 256.
- Magazzino, C., 2014. A panel VAR approach of the relationship among economic growth, CO<sub>2</sub> emissions, and energy use in the ASEAN-6 countries. *Int. J. Energy Econ. Policy* 4 (4), 546–553.
- Magazzino, C., 2016. CO<sub>2</sub> emissions, economic growth, and energy use in the Middle East countries: a panel VAR approach. *Energy Sources, Part B: Economics, Planning, and Policy* 11 (10), 960–968.
- Magazzino, C., Cerulli, G., 2019. The determinants of CO<sub>2</sub> emissions in MENA countries: a responsiveness scores approach. *International Journal of Sustainable Development & World Ecology* 26 (6), 522–534.
- Magazzino, M., Mele, M., Schneider, N., 2020a. The relationship between municipal solid waste and greenhouse gas emissions: evidence from Switzerland. *Waste Manag.* 113, 508–520.
- Magazzino, C., Mele, M., Schneider, N., 2020b. The relationship between air pollution and COVID-19-related deaths: An application to three French cities. *Appl. Energy* 279, 115835. <https://doi.org/10.1016/j.apenergy.2020.115835>.
- Magazzino, C., Mele, M., Schneider, N., Vallet, G., 2020c. The relationship between nuclear energy consumption and economic growth: evidence from Switzerland. *Environ. Res. Lett.* 15, 0940a5.
- Malinauskaitė, J., Jouhara, H., Czajczyńska, D., Stanchev, P., Katsou, E., Rostowski, P., Thorne, R.J., Colón, J., Ponsá, S., Al-Mansour, F., Anguilano, L., Krzyżyńska, R., López, I.C., Vlasopoulos, A., Spencer, N., 2017. Municipal solid waste management and waste-to-energy in the context of a circular economy and energy recycling in Europe. *Energy* 141, 2013–2044.
- Martel, A., Klibi, W., 2016. *Designing Value-creating Supply Chain Networks*. Springer, Cham.
- Mazzanti, M., 2008. Is waste generation de-linking from economic growth? Empirical evidence for Europe. *Appl. Econ. Lett.* 15 (4), 287–291.
- Mazzanti, M., Zoboli, R., 2005. Delinking and environmental Kuznets curves for waste indicators in Europe. *Environ. Sci.* 2 (4), 409–425.
- Mazzanti, M., Zoboli, R., 2008. Waste generation, waste disposal and policy effectiveness: evidence on decoupling from the European Union. *Resources, Conservation and Recycling* 52 (10), 1221–1234.
- Mazzanti, M., Montini, A., Zoboli, R., 2006. Municipal waste production, economic drivers, and new waste policies: EKC evidence from Italian regional and provincial panel data. *Fondazione Enrico Mattei Working Papers*, p. 155.
- McCulloch, W.S., Pitts, W.H., 1943. A logical calculus of the ideas immanent in nervous activity. *Bull. Math. Biophys.* 7, 115–133.
- Mele, M., Magazzino, C., 2020. A machine learning analysis of the relationship among iron and steel industries, air pollution, and economic growth in China. *J. Clean. Prod.* 277, 123293.
- Meza, J.K.S., Yepes, D.O., Rodrigo-Illarri, J., Cassiraga, E., 2019. Predictive analysis of urban waste generation for the city of Bogotá, Colombia, through the implementation of decision tree-based machine learning, support vector machines and artificial neural networks. *Heliyon* 5, 1–11.
- Mst.dk, 2015. Denmark without Waste II. Retrieved from. <https://buff.ly/3ilmCT5>.
- Munir, Q., Lean, H.H., Smyth, R., 2020. CO<sub>2</sub> emissions, energy consumption and economic growth in the ASEAN-5 countries: a cross-sectional dependence approach. *Energy Econ.* 85, 104571.
- OECD, 2019a. Available. [https://www.eea.europa.eu/ds\\_resolveuid/BJOQUP715R](https://www.eea.europa.eu/ds_resolveuid/BJOQUP715R).
- OECD, 2019b. *Global Material Resources Outlook to 2060: Economic Drivers and Environmental Consequences*. OECD Publishing, Paris <https://doi.org/10.1787/9789264307452-en>.
- Pan, A., Yu, L., Yang, Q., 2019. Characteristics and forecasting of municipal solid waste generation in China. *Sustainability* 11 (5), 1–11.
- Pao, H.T., Tsai, C.M., 2011. Multivariate Granger causality between CO<sub>2</sub> emissions, energy consumption, FDI (foreign direct investment) and GDP (gross domestic product): evidence from a panel of BRIC (Brazil, Russian Federation, India, and China) countries. *Energy* 36 (1), 685–693.
- Pearl, J., 2009. *Causality*. Cambridge University Press, Cambridge.
- Pesaran, H. Hashem, Shin, Y., 1998. Generalized impulse response analysis in linear multivariate models. *Econ. Lett.* 58 (1), 17–29.
- Pesaran, M. Hashem, Shin, Y., Smith, Richard J., 2001. Bounds testing approaches to the analysis of level relationships. *J. Appl. Econ.* 16 (3), 289–326.
- Rothman, D.S., De Bruyn, S.M., 1998. Probing into the environmental Kuznets curve hypothesis. *Ecol. Econ.* 25, 143–145.
- Saidi, K., Hammami, S., 2015. The impact of energy consumption and CO<sub>2</sub> emissions on economic growth: fresh evidence from dynamic simultaneous-equations models. *Sustain. Cities Soc.* 14, 178–186.
- Sarkodie, S.A., 2020. Causal effect of environmental factors, economic indicators and domestic material consumption using frequency domain causality test. *Sci. Total Environ.* 736, 139602. <https://doi.org/10.1016/j.scitotenv.2020.139602>.
- Sarkodie, S.A., 2021. Environmental performance, biopacity, carbon & ecological footprint of nations: drivers, trends and mitigation options. *Sci. Total Environ.* <https://doi.org/10.1016/j.scitotenv.2020.141912>.
- Sarkodie, S.A., Adom, P.K., 2018. Determinants of energy consumption in Kenya: a NIPALS approach. *Energy* 159, 696–705. <https://doi.org/10.1016/j.energy.2018.06.195>.
- Sarkodie, S.A., Owusu, P.A., 2020. Impact of COVID-19 pandemic on waste management. *Environment, Development and Sustainability* <https://doi.org/10.1007/s10668-020-00956-y>.

- Sarkodie, S.A., Strezov, V., 2019. A review on environmental Kuznets curve hypothesis using bibliometric and meta-analysis. *Sci. Total Environ.* 649, 128–145.
- Shafiei, S., Salim, R.A., 2014. Non-renewable and renewable energy consumption and CO<sub>2</sub> emissions in OECD countries: a comparative analysis. *Energy Policy* 66, 547–556.
- Silva, S., Soares, I., Pinho, C., 2012. The impact of renewable energy sources on economic growth and CO<sub>2</sub> emissions—a SVAR approach. *European Research Studies* 15, 133.
- Sjöström, M., Östblom, G., 2010. Decoupling waste generation from economic growth – a CGE analysis of the Swedish case. *Ecol. Econ.* 69 (7), 1545–1552.
- Sokka, L., Antikainen, R., Kauppi, P.E., 2007. Municipal solid waste production and composition in Finland – changes in the period 1960–2002 and prospects until 2020. *Resources, Conservation and Recycling* 50 (4), 475–488.
- Stern, D.I., 2004. The rise and fall of the environmental Kuznets curve. *World Dev.* 32 (8), 1419–1438.
- Stern, D.I., Common, M.S., 2001. Is there an environmental Kuznets curve for sulfur? *J. Environ. Econ. Manag.* 41 (2), 162–178.
- Tiwari, A.K., 2011. A structural VAR analysis of renewable energy consumption, real GDP and CO<sub>2</sub> emissions: evidence from India. *Econ. Bull.* 31 (2), 1793–1806.
- Toda, H.Y., Yamamoto, T., 1995. Statistical inference in vector autoregressions with possibly integrated processes. *J. Econ.* 66 (1–2), 225–250.
- Tomić, T., Dominković, D.F., Pfeifer, A., Schneider, D.R., Pedersen, A.S., Duić, N., 2017. Waste to energy plant operation under the influence of market and legislation conditioned changes. *Energy* 137, 1119–1129.
- United Nations, 2015. Sustainable Development Goals. Retrieved from. <https://sustainabledevelopment.un.org/?menu=1300>.
- Van Fan, Y., et al., 2020. Implementing Circular Economy in municipal solid waste treatment system using P-graph. *Sci. Total Environ.* 701, 134652.
- Wang, Y.C., 2013. Functional sensitivity of testing the environmental Kuznets curve hypothesis. *Resour. Energy Econ.* 35 (4), 451–466.
- Wanner, T., 2015. The new 'passive revolution' of the green economy and growth discourse: maintaining the 'sustainable development' of neoliberal capitalism. *New Political Economy* 20 (1), 21–41.
- WDI, 2019. Available at: [t. https://databank.worldbank.org/source/world-development-indicators](https://databank.worldbank.org/source/world-development-indicators).
- Woon, K.S., Lo, I.M., 2013. Greenhouse gas accounting of the proposed landfill extension and advanced incineration facility for municipal solid waste management in Hong Kong. *Sci. Total Environ.* 458, 499–507.
- Yang, N., Zhang, H., Chen, M., Shao, L.M., He, P.J., 2012. Greenhouse gas emissions from MSW incineration in China: impacts of waste characteristics and energy recovery. *Waste Manag.* 32 (12), 2552–2560.
- Yi, S., Yang, H., Lee, S.H., An, K.J., 2014. Quantifying and managing regional greenhouse gas emissions: waste sector of Daejeon, Korea. *Journal of Environmental Sciences* 26 (6), 1249–1259.